

Article number: 20664270A

Description: E+G Levelling set
GN 350.1-80-26-ST

Measures

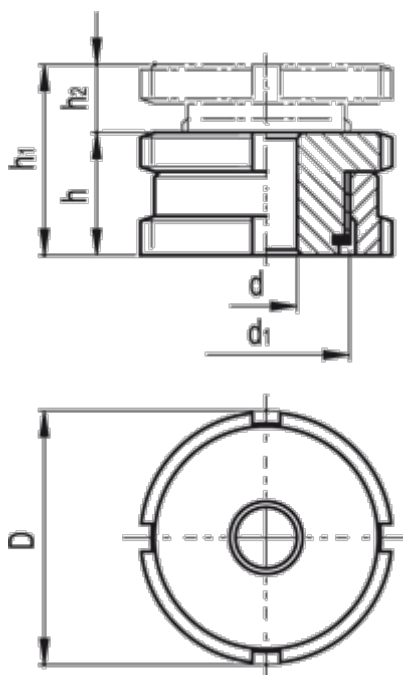

C-spanner DIN 1810 = A80-90	
d	= 26.0
D	= 80
d1	= M60x2
For screw	= M24
h	= 38
h1	= 50
h2	= 12

Max static load (N)	= 495.0
Static preload (N)	= 322.0
Weight (g)	= 1135